



# TechBook

in.xe

innovative spa pack platform



Versatile

---

Easy to install

---

watertight







---

## Table of contents

Warnings .....	2
Introduction .....	3
Features .....	4
Overview	
- in.xe dimensions .....	5
Installation	
- Floor installation procedure .....	6
- Wall installation procedure .....	6
- Keypad installation .....	7
Connections	
- Connection of main keypad .....	8
- heat.wav water heater connections .....	8
- Connecting high voltage accessories .....	9
- in.link output connectors .....	9
Wiring	
- in.link connector .....	10
Electrical wiring	
- Electrical wiring: all models .....	14
- Electrical wiring: North American models .....	15
- Electrical wiring: European models .....	15
Controler power up .....	16
Compatible keypads .....	17
Troubleshooting .....	18
Specifications .....	19



## Warnings



### **WARNINGS:**

Before installing or connecting the unit, please read the following.

- \* FOR UNITS FOR USE IN OTHER THAN SINGLE-FAMILY DWELLINGS, A CLEARLY LABELED EMERGENCY SWITCH SHALL BE PROVIDED AS PART OF THE INSTALLATION. THE SWITCH SHALL BE READILY ACCESSIBLE TO THE OCCUPANTS AND SHALL BE INSTALLED AT LEAST 5' (1.52 M) AWAY, ADJACENT TO, AND WITHIN SIGHT OF THE UNIT.
- \* ANY DAMAGED CABLE MUST BE IMMEDIATELY REPLACED BY QUALIFIED PERSONNEL.
- \* TURN POWER OFF BEFORE SERVICING OR MODIFYING ANY CABLE CONNECTIONS IN THIS UNIT.
- \* TO PREVENT ELECTRIC SHOCK HAZARD AND/OR WATER DAMAGE TO THIS CONTROL, ALL UNUSED BUSHING CONDUITS MUST BE PLUGGED WITH THE ATTACHED NIPPLE.
- \* THIS CONTROLLER MUST NOT BE INSTALLED IN PROXIMITY OF HIGHLY FLAMMABLE MATERIALS.
- \* LOW SUPPLY VOLTAGE OR IMPROPER WIRING MAY CAUSE DAMAGE TO THIS CONTROL SYSTEM. READ AND FOLLOW ALL WIRING INSTRUCTIONS WHEN CONNECTING TO POWER SUPPLY.
- \* THIS PACK CONTAINS NO USER SERVICEABLE PARTS. CONTACT AN AUTHORIZED SERVICE CENTER FOR SERVICE.
- \* ALL CONNECTIONS MUST BE MADE BY A QUALIFIED ELECTRICIAN IN ACCORDANCE WITH THE NATIONAL ELECTRICAL CODE AND ANY STATE, PROVINCIAL OR LOCAL ELECTRICAL CODE IN EFFECT AT THE TIME OF THE INSTALLATION.
- \* PRODUCT MUST BE DISPOSED OF SEPARATELY IN ACCORDANCE WITH LOCAL WASTE DISPOSAL LEGISLATION.
- \* THIS APPLIANCE IS NOT INTENDED FOR USE BY PERSONS (INCLUDING CHILDREN) WITH REDUCED PHYSICAL, SENSORY OR MENTAL CAPABILITIES, OR LACK OF EXPERIENCE AND KNOWLEDGE, UNLESS THEY HAVE BEEN GIVEN SUPERVISION OR INSTRUCTION CONCERNING USE OF THE APPLIANCE BY A PERSON RESPONSIBLE FOR THEIR SAFETY.
- \* CHILDREN SHOULD BE SUPERVISED TO ENSURE THAT THEY DO NOT PLAY WITH THE APPLIANCE.
- \* MEANS FOR DISCONNECTION MUST BE INCORPORATED IN THE FIXED WIRING IN ACCORDANCE WITH THE WIRING RULES.
- \* CAUTION: IN ORDER TO AVOID A HAZARD DUE TO INADVERTENT RESETTING OF THE THERMAL CUT-OUT, THIS APPLIANCE MUST NOT BE SUPPLIED THROUGH AN EXTERNAL SWITCHING DEVICE, SUCH AS A TIMER, OR CONNECTED TO A CIRCUIT THAT IS REGULARLY SWITCHED ON AND OFF BY THE UTILITY.
- \* PARTS CONTAINING LIVE PARTS, EXCEPT PARTS SUPPLIED WITH SAFETY EXTRA-LOW VOLTAGE NOT EXCEEDING 12 V, MUST BE INACCESSIBLE TO A PERSON IN THE BATH OR SPA.
- \* PARTS INCORPORATING ELECTRICAL COMPONENTS, EXCEPT REMOTE CONTROL DEVICES, MUST BE LOCATED OR FIXED SO THAT THEY CANNOT FALL INTO THE BATH OR SPA.
- \* PARTS ARE TO BE INSTALLED IN THE CORRECT ZONE AND EQUIPOTENTIAL BONDING CARRIED-OUT IN ACCORDANCE WITH THE WIRING RULES.
- \* CLEARANCE AND MINIMUM DISTANCE BETWEEN THE VARIOUS PARTS OF THE APPLIANCE AND THE SURROUNDING STRUCTURE ARE NOT SPECIFIED AS LONG AS THEY ARE SUFFICIENT SO THAT THE AMBIENT TEMPERATURE AROUND THE CONTROLLER DOES NOT EXCEED 50 OR 60°C.

Aeware®, Gecko®, and their respective logos are Registered Trademarks of Gecko Alliance Group. in.xe™, in.access™, in.keys™, in.touch™, in.k200™, in.k400™, in.k450™, in.k600™, K-19™, K-35™, K-8™, in.k1000™, in.k800™, in.k500™, in.k300™, in.flo™, in.put™, in.seal™, in.link™, in.t.cip™, in.stik™, heat.wav™, Y Series™ and their respective logos are Trademarks of Gecko Alliance Group.

All other product or company names that may be mentioned in this publication are tradenames, trademarks or registered trademarks of their respective owners.



---

## Introduction



# in.xe

## Entry-level spa system

Congratulations! You have purchased one of the finest entry-level spa packs available.

To install, use and enjoy your in.xe spa system take the time to carefully read these instructions.

The in.xe is designed for these typical spa configurations:

- Single pump system
- Dual pump system
- Pump & blower system
- Dual pump & blower system

The in.xe can be wall-mounted or installed on its mounting base and comes with an integrated heat.wav water heater.



## Features

The in.xe system boasts a long list of technical features. Each of them contributes to bringing the most advanced solutions available to in.xe equipped spa owners:



**in.seal**  
watertight protection

In.seal provides an extra level of protection against water infiltration. Connectors and power box are designed to be watertight so that no water can be in direct contact with electrical components (IPX5).



**in.flo**  
dry-fire protection

in.flo is an all-electronic dry-fire protection that is built on the heat.wav heater. The in.flo eliminates the burden of adjustments, calibrations and failures associated to usual water flow sensors.



**in.stik**  
automated software upload

The in.stik is a pen drive with an in.link connector very similar to a USB memory stick. It connects to the spa pack and contains data to program or configure its system. The system executes the data upload automatically.



**in.t.cip**  
water temperature algorithm

in.t.cip is an intelligent water temperature refresh algorithm that calculates optimal time to start pumps and get water temperature readings. In.t.cip continuously readjusts the heater start time (according to exterior temperature).



**in.touch**  
you're always in touch with your relaxation

The in.xe support the in.touch WiFi interface, allowing you to use your favorite iOS device to communicate with your spa.



**in.axess**  
board access prevention

Electronic components are placed into separate and inaccessible compartments. Only serviceable parts are made accessible to service technicians.



**in.put**  
input terminal block

The in.put was designed to ease wire insertion (up to # 4AWG) and connections. Tighter input connection reduces heat generated for increased component lifetime.



**in.kin**  
kinetic heat monitoring

First ever UL approved kinetic heating protection manages water temp increase generated by pump heat dissipation. Hardware protection shuts all accessories off if it senses water overheating.



**in.link**  
plugs and connectors

in.link cables are output and input plugs and connectors that come with colored and tagged polarizers. Totally waterproof, they are designed to be easily configured and to ensure that all cables of equipment used to make a spa or hot tub work properly are well connected at their intended connection port, eliminating any risk of miswiring.



## Overview

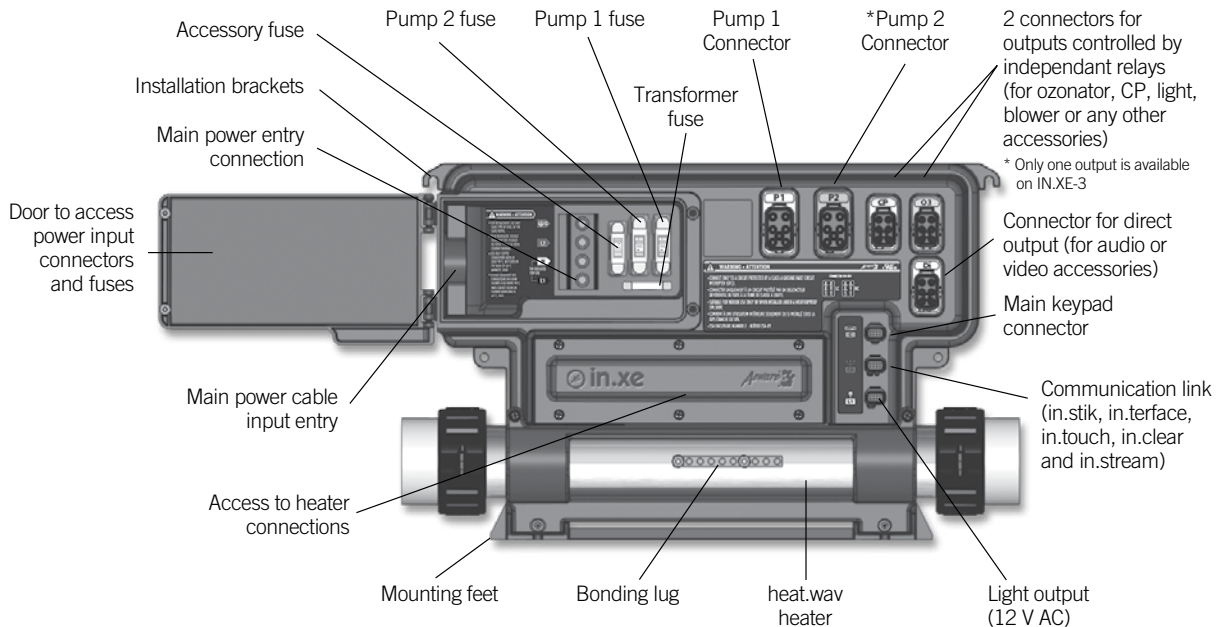

Note: No connectors should remain unplugged. Use blank plugs to fill unused connectors.

\* Available only on IN.XE-5.

## in.xe dimensions

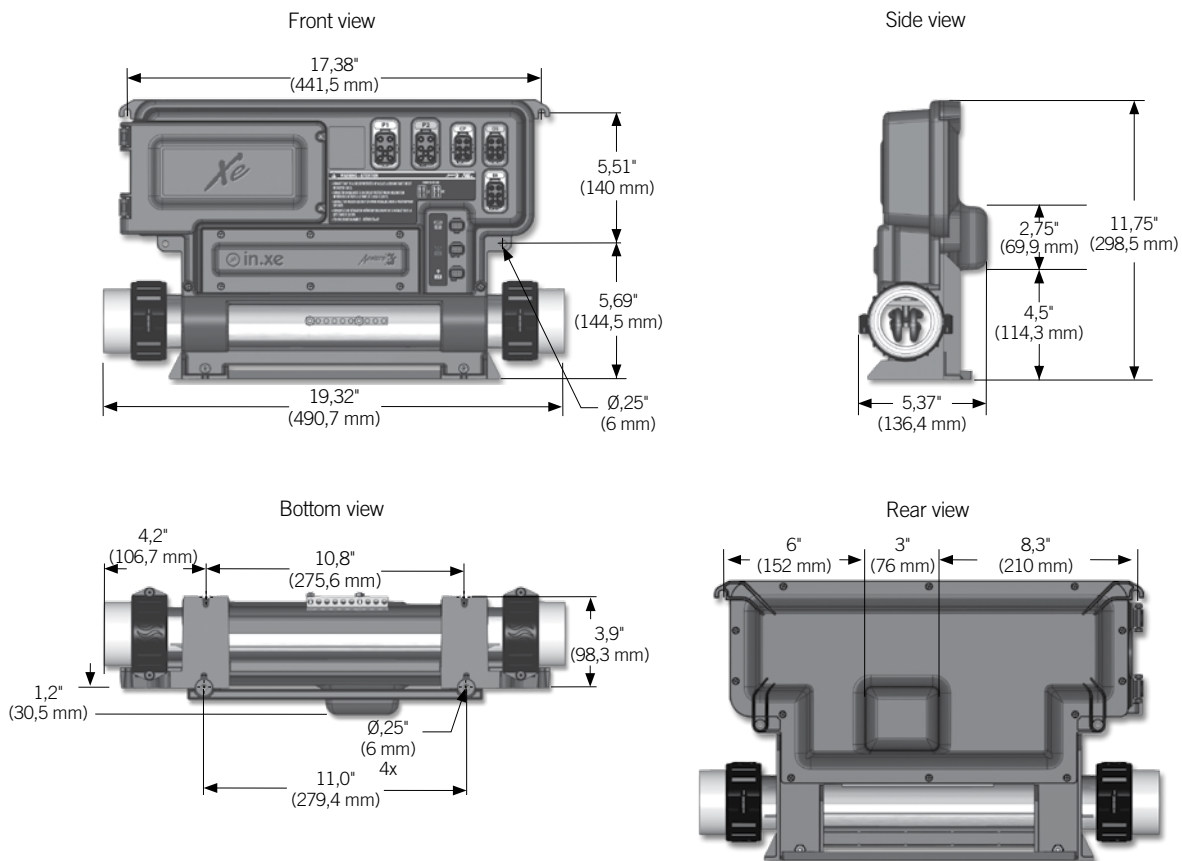



## Installation

### Floor installation procedure

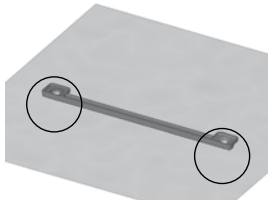

**The following material is recommended:**

4- # 10 screws of appropriate length with round, truss or pan head.

4- washers .5" OD x .0625" thickness (12 mm OD x 1.5 mm)

Select the most appropriate location on the floor for spa pack and firmly attach guide plate to wooden base with 2 screws backed by 2 washers.

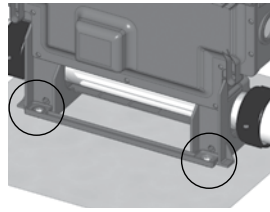

Slide the rear of the spa pack in the guide plate. It should easily slide into place.

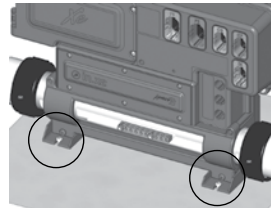

Now firmly attach unit to wooden base by using the remaining 2 screws backed by 2 washers to attach the front of the spa pack.

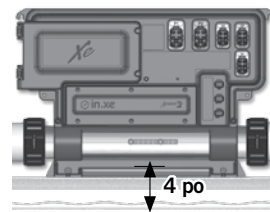

**Note:** The spa pack must be installed at least 4" (100 mm) above potential flood level. If floor is on ground level, pack should be raised at least 4" (100 mm).



**Warning!**

Beware of the application of some products commonly used against corrosion (such as WD-40 family products) as they could damage the pack, due to a negative chemical reaction between some industrial oils and its plastic enclosure. Any other materials which may come in contact with the enclosure must be carefully evaluated under end use conditions for compatibility.

**Important!**

Please note that countersunk screws should not be used as they can damage the supports of the in.xe enclosure.

### Wall installation procedure



**The following material is recommended:**

4- # 10 screws of appropriate length with round, truss or pan head.

4- washers .5" OD x .0625" thickness (12 mm OD x 1.5 mm)

Use two standard wall studs (2x4 or 2x6), spaced 16-inch from center to center to fix the spa pack.



In the case of a flat wooden surface: select the most appropriate location on wall for the spa pack. A 4" (100 mm) square cut-out will be needed to allow the transformer to fit through it.

Firmly attach, one at a time, upper mounting holes on each side of the spa pack with 2 screws backed by 2 washers.



Firmly attach lower mounting holes on each side of the pack with the 2 remaining screws and 2 washers.

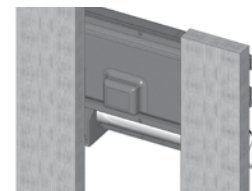

**Note:** Make sure these 2 screws and 2 washers are installed. They ensure the stability of the spa pack upon the insertion of the input connector, output and accessories in their respective port.





---

## Installation

### Keypad installation

For detailed instructions and drilling template, refer to the [compatible keypad](#) section and select your keypad to be redirected to the corresponding techbook.



## Connections

### Connection of main keypad

*Note: always shut power down before connecting an accessory to the in.xe.*

To connect the keypad insert the in.link connector into the appropriate keypad connector (as illustrated.)

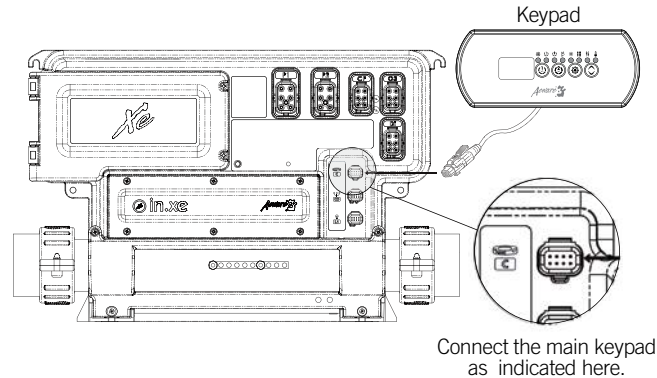

### heat.wav water heater connections

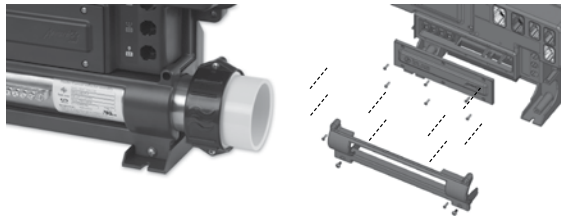

in.xe comes with a high performance heat.wav heater. With no pressure switch, it features in.flo integrated dry-fire protection.

A watertight panel protects the connections of the water heater. By removing this one, they become accessible. The connections include the dry fire protection (in.flo) and the connector for the hi-limit/regulation probe.

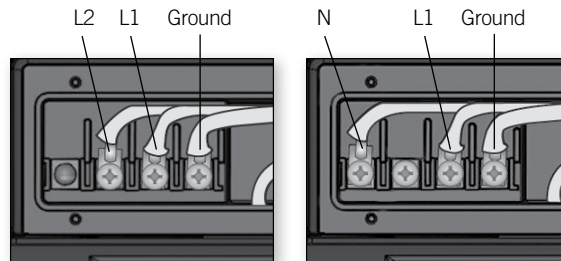

**Connections for 230/240 V heater (5,5 kW, 4 kW ou 2 kW)**

**Connections for 120 V heater (1 kW)**

The heat.wav heater is factory configured 240 V / 4 kW, but it can be converted to a dedicated 120 V / 1 kW by simply switching a cable connection port (option available on North American models only).

The heat.wav heater is also offered in 240 V / 5,5 kW or 240 V / 2 kW versions.

heat.wav specification summary:

- Supports 120 V or 240 V
- 240 V / 5,5 kW or 240 V / 2 kW optional heater offered
- Protected by external breaker(not fused)\*
- Incoloy® heater element

\* Note: European models are 230-240 V only and are fuse protected.



## Connections

### Connecting high voltage accessories

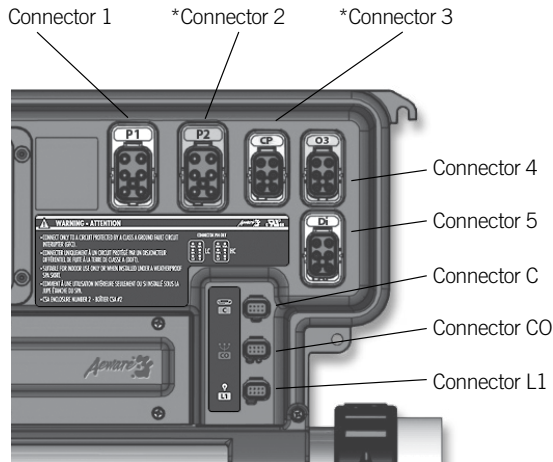

Female connector on spa pack

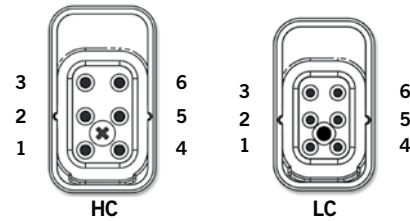

\* Only available on IN.XE-5.

### in.link output connectors

#### High-Current - HC connectors:

Connector	Output	Typical Device
Connector 1	Output 1	Pump 1 high speed
	Output 2	Pump 1 low speed
Connector 2*	Output 3	Pump 2 high speed

#### Low-Current - LC connectors (relay controlled):

Connector	Output	Typical Device
Connector 3*	Output 4	Blower
Connector 4	Output 5	Ozonator

#### Low-Current - LC connectors (always on)

Connector	Output	Typical Device
Connector 5	Output 6	Audio/video/etc. accessories

#### Low voltage connectors - LV

Connector C	Main keypad
Connector CO	Communication port (in.stik, in.clear, etc)
Connector L1	Light output 12V AC

\* Only available on IN.XE-5.



## Wiring

### in.link connector

The in.xe features in.link connectors with colored and tagged polarizers. This new plug and connector technology has been specifically designed for easy and safe assembly. The tags are interchangeable depending on the output and the polarizers are designed to avoid misconnections.

in.link connectors are easily and conveniently accessible from the front of the pack offering a wide range of possible connection configurations. In.link connectors come in 3 sizes (HC, LC and low voltage) for all types of inputs and output devices.

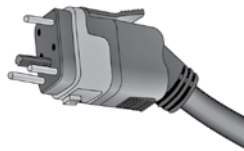

**HC**  
High Current connector



**LC**  
Low Current connector



Low voltage connector

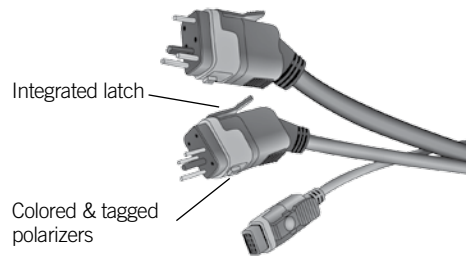
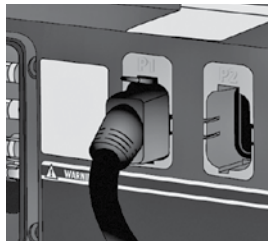

### Latch snap & strain relief

A latch mechanism is provided to maintain male and female connectors together. The tab provided on the male part gives the operator an audible and tactile feedback at the insertion of the cable in the female part. Once the latch is engaged, it will prevent both parts from separating unintentionally by vibration or shock. To unplug the male connector, a gentle press on the tab will allow the release of the locking mechanism to separate both parts.

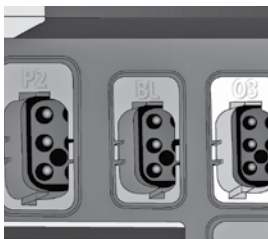

### Watertight design UL & CE

The female connector comes with a built-in seal ensuring a watertight connection assembly sealed from moisture and water ingress. This sealing is intended to be suitable for the North American and European standards and the demanding spa environment.



## Wiring

### Dual speed, 240 V, high current (HC) cable kit in.link



High Current connector

Gecko P/N	Description	Typical use	Cable	Length
600DB0821	Cable in.link HC 2S 15A 240 V 8' T	dual-output loads up to 15 FLA (pump dual speed)	14/4	96"
600DB0967	Cable in.link HC 2S 15A 240 V 8' T CE	dual-output loads up to 15 FLA (pump dual speed) for Europe	14/4	96"

### Single speed, 240 V, high current (HC) cable kit in.link



High Current connector

Gecko P/N	Description	Typical use	Cable	Length
600DB0833	Cable in.link HC 1S 15A 240 V 8' T	single-output loads up to 15 FLA (pump single speed)	14/3	96"
600DB0901	Cable in.link HC 1S 15A 240 V 8' T CE	single-output loads up to 15 FLA (pump single speed) for Europe	14/3	96"

### Dual speed, 120 V, high current (HC) cable kit in.link



High Current connector

Gecko P/N	Description	Typical use	Cable	Length
9920-401239	Cable in.link HC 2S 15A 120 V 8' T	dual-output loads up to 15 FLA (pump dual speed)	14/4	96"

### Single speed, 120 V, high current (HC) cable kit in.link



High Current connector

Gecko P/N	Description	Typical use	Cable	Length
600DB0857	Cable in.link HC 1S 15A 120 V 8' T	single-output loads up to 15 FLA (pump single speed)	14/3	96"



## Wiring

### Single speed, 240 V, low current (LC) cable kit [in.link](#)



Low current connector

Gecko P/N	Description	Typical use	Cable	Length
600DB1192	Cable in.link LC 1S 5A 240 V 8' T	single output loads up to 5 FLA(ozone, blower, circ. pump, DC supply, etc.)	18/3	96"
600DB1259	Cable in.link LC 1S 5A 240 V 8' T CE	single output loads up to 5 FLA(ozone, blower, circ. pump, DC supply, etc.) for Europe	18/3	96"

### Single speed, 120 V, low current (LC) cable kit [in.link](#)



Low current connector

Gecko P/N	Description	Typical use	Cable	Length
600DB1226	Cable in.link LC 1S 5A 120 V 8' T	single output loads up to 5 FLA (ozone, blower, circ. pump, DC supply, etc.)	18/3	96"

### Low voltage (LV) cable kit [in.link](#)



Low voltage connector

Gecko P/N	Description	Typical use	Cable	Length
9920-401022	Cable in.link LV Light 12 V AC 12'	Light 12 V AC	24/4	144"



---

## Wiring

### Polarizer for in.link cable 120 V and 240 V



Gecko P/N	Description	Typical use
9917-100894	Polarizer LV - BL - blue	Polarizer for low current cable for blower
9917-100895	Polarizer LV - CP - green	Polarizer for low current cable for circulation pump
9917-100898	Polarizer LV - O3 - grey	Polarizer for low current cable for ozonator
9917-100887	Polarizer HV - P2 - violet	Polarizer for high current cable for Pump 2
9917-100888	Polarizer HV - P1 - orange	Polarizer for high current cable for Pump 1



## Electrical wiring

### Electrical wiring: all models

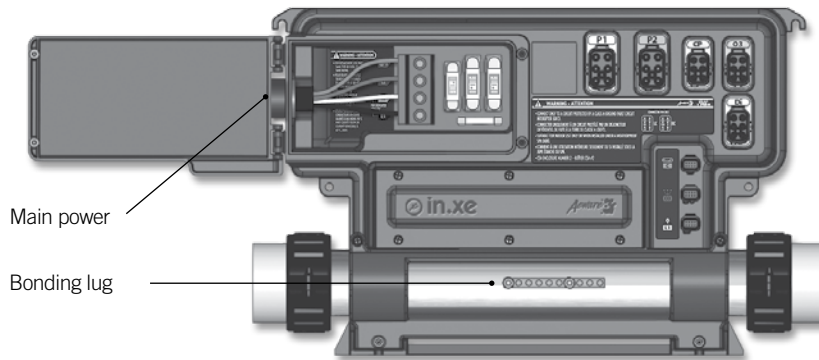

**Warning**  
 Cut electrical power before proceeding to any electrical job. The wiring must be done by a qualified electrician in accordance to local electric code.

To complete the electrical connections of the control system you will need a Phillips screwdriver and a flat-head screwdriver.

Loosen the 2 screws of the spa pack door and open it.

Remove 5 1/2" (142 mm) of cable insulation.

Strip away 1" (25 mm) of insulation from each wire.

Pull the cable through the cutout of the box and secure it with a strain relief (1" NPT strain relief; hole diameter: 1.335" (34,42 mm)). Ensure that the NPT strain relief clamps around the outer sheath of the cable.

*\* For CE use an IEC certified plastic bushing that will maintain the IPX5 rating.*

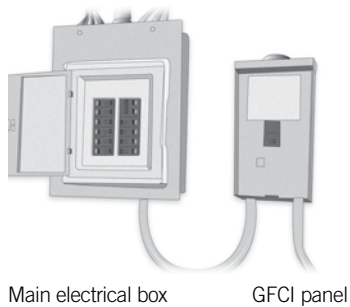

**Warning**  
 For units for use in other than single-family dwellings, a clearly labeled emergency switch shall be provided as part of the installation. The switch shall be readily accessible to the occupants and shall be installed at least 5' (1.52 m) away, adjacent to, and within sight of the unit.

-----  
 This product must always be connected to a circuit protected by a ground fault interrupter.

-----  
 Proper wiring of the electrical service box, GFCI and in.xe terminal block is essential!

-----  
 Check your electrical code for local regulations. Only copper wire should be used, never aluminum.

**Disposal of the product**  
 The appliance (or the product) must be disposed of separately in accordance with the local waste disposal legislation in force.





## Electrical wiring

### Electrical wiring: North American models

Insert each wire into the appropriate socket of the main entry terminal block according to the color code indicated on the sticker. Use a Phillips or flathead screwdriver to tighten screws.

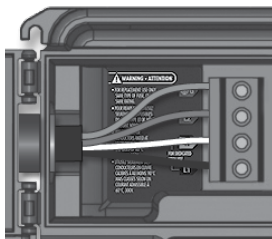

**For 240 V (4 wires)**

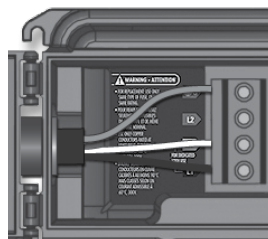

**For 120 V (\*3 wires)**

\*If connected to a 3 wires system, no 240 V component will work.

To change the configuration of your heat.wav, refer to «Connections for 120 V heater» section of this manual.

Connect the bonding conductor to the bonding lug on the front of the spa pack (a grounded electrode conductor should be used to connect the equipment grounding conductors).

### Electrical wiring: European models

Insert each wire into the appropriate socket of the main entry terminal block according to the color code indicated on the sticker. Use a Phillips or flathead screwdriver to tighten screws.

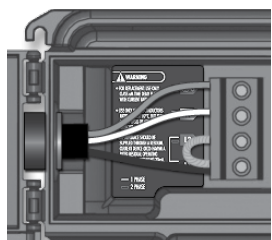

Single-phase

**230 V (3 wires)**

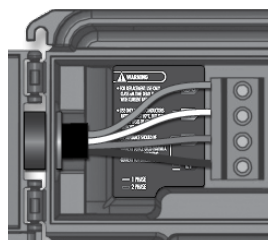

Dual-phase

**230 V / 400 V (4 wires)**

#### **Warning**

in.xe.ce models must always be connected to a circuit protected by a Residual-Current Device (RCD) having a rated operating residual-current not exceeding 30 mA

Install a jumper between line 1 (L1) and line 2 (L2).

Connect the bonding conductor to the bonding lug on the front of the spa pack (a grounded electrode conductor should be used to connect the equipment grounding conductors).



## Controller power up

### Start up of your control system

To perform the control system start up, refer to the manual:

[Start up guide and basic configuration](#)





## Compatible keypads

### List of compatible keypads for the in.xe control system

For more information on the compatible keypads for your control system refer to the corresponding Techbook.



[K-19 main keypad](#)  
LED display, 4 keys



[K-35 main keypad](#)  
LED display, 6 keys



[in.k200 main keypad](#)  
LED display, 4 keys



[in.k600 static main keypad](#)  
LCD display, 11 keys



[K-4 main keypad](#)  
LCD display, 8 keys



[K-8 main keypad](#)  
LCD display, 8 keys



[in.k450 main keypad](#)  
LCD display, 7 keys



[in.k300 main keypad](#)  
LCD display, 4 keys



[in.k500 main keypad](#)  
Color LCD display, 7 keys



[in.k800 main keypad](#)  
Color LCD display, 10 keys



[in.k1000 main keypad](#)  
Color LCD capacitive  
touchscreen display



# Troubleshooting

## Troubleshooting information for your control system

You come across a problem with your control system, for the troubleshooting of your control system, refer to the manual: [Troubleshooting guide](#)





## Specifications

### Environmental ratings

<b>Operating temperature:</b>	<p><b>North American models in.xe:</b> 32°F (0°C) to 140°F (60°C) for pump 1 up to 15 A 32°F (0°C) to 122°F (50°C) for pump 1 up to 20 A</p> <p><b>European models in.xe.ce:</b> For single-phase system (32 A Max) or 2-phase (2 x 16 A) 32°F (0°C) to 140°F (60°C) For single-phase system (40 A Max) or 2-phase (2 x 20 A) 32°F (0°C) to 122°F (50°C) (*Controller must be installed under the spa skirt)</p>
<b>Storage temperature:</b>	-13°F (-25°C) to 185°F (85°C)
<b>Humidity:</b>	Up to 85% RH, non condensing

### Mechanical:

<b>Weight:</b>	10.5 lb (4.76 kg)
<b>Dimensions (W x H x D):</b>	17,38" x 11,75" x 5,1" (441,5 x 298,5 x 129 mm)

### in.xe North American electrical specifications

<b>Input rating:</b>	120/240 V nominal (+ 5/- 10 %), 60 Hz, (2 lines required with neutral) 48 A Max.
<b>or:</b>	120 V nominal only (+ 5/- 10 %), 60 Hz, (single line with neutral) 16 A Max.
<b>heat.wav rating:</b>	
<b>Voltage:</b>	120 V or 240 V, 60 Hz
<b>Wattage:</b>	5,5 kW at 240 V, 4 kW at 240 V, 1 kW at 120 V
<b>Flow rate:</b>	Minimum of 18 GPM (68,1 LPM) is required

Output	Voltage	Maximum current	Typical Device
Output 1	120/240 V	20 FLA/70 LRA (in-rush)	Pump 1 high speed
	120/240 V	15 FLA/60 LRA (in-rush)	Pump 1 low speed
Output 2*	240 V	15 FLA/60 LRA (in-rush)	Pump 2
Output 3*	120/240 V	6 FLA/10 A	(CP)/Blower
Output 4	120/240 V	6 FLA/10 A	Ozone generator
Output 5	120/240 V	10 A (always ON)	Audio/video
L1	12 V AC	1 A	Light

### Important:

The maximum power for Outputs 3 to 5 on fuse F3 cannot be over 12 A.

### UL/CSA Standards

UL 1563 sixth ed. (2012)  
UL file: E182156  
CSA No. 22.2 - 218.1-M89 (2013)



\* Available only for le IN.XE-5



## Specifications

### in.xe European electrical specifications

**Input rating:** 230/400 V nominal (+ 5/- 10 %) (dual-phased system) 20 A Max per phase  
**or:** 230 V nominal (+ 5/- 10 %) (single-phased system) 40 A Max

#### heat.wav rating:

**Voltage:** 230 V, 50 Hz  
**Wattage:** 3,8 kW at 230 V, 2 kW at 230 V, 1,3 kW at 230 V  
**Flow rate:** A minimum of 18 GPM (68,1 LPM) is required

Output	Voltage	Maximum current	Typical Device
Output 1	230 V	15 FLA/60 LRA (in-rush)	Pump 1 high and low
Output 2*	230 V	15 FLA/60 LRA (in-rush)	Pump 2
Output 3*	230 V	6 FLA/10 A	(CP)/Blower
Output 4	230 V	6 FLA/10 A	Ozone generator
Output 5	230 V	10 A (always ON)	Audio/video
L1	12 V AC	1 A	Light

### TUV Standards

EN/IEC 60335 - 1 - 1: /A15:2011 - EN/IEC 60335 - 2 - 60: /A12:2010  
 EN55014-1  
 EN55014-2  
 EN61000-3-2  
 EN61000-3-3



The in.xe.ce is lab tested to IPx5 enclosure protection levels.

#### IPx5 level of waterproofing is conditional on 3 items:

- Both front covers (heater and input wiring) are closed and screwed.
- A suitable waterproof strain-relief / bushing is used for the cable entry into the pack.
- Any unused in.link connection (HC, LC, or low voltage) is plugged with the appropriate blank plug.

\* Available only for le IN.XE-5





9919-100760-D  
Rev. 11-2015

© Groupe Gecko Alliance Inc., 2015  
All trademarks or registered trademarks  
are the property of their respective owners.

Gecko Alliance  
450 des Canetons, Québec (Qc), G2E 5W6 Canada, 1.800.78.GECKO  
[www.geckoalliance.com](http://www.geckoalliance.com)

Printed in Canada 11-2015